

“Perfis de PVC e borracha com inserção metálica”

CATÁLOGO de Perfis 2015

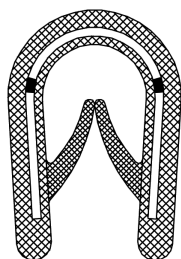

Perfis PVC

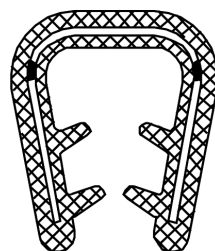

Perfis borracha

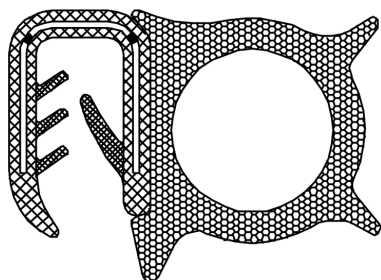

Perfis PVC + Borracha

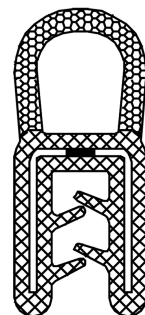

Perfis Borracha + Borracha

Perfis de PVC com inserção metálica

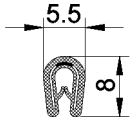
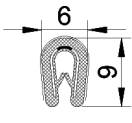
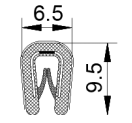
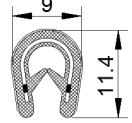
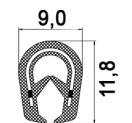
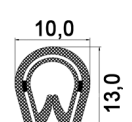
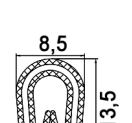
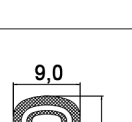
Plano 1:1	Referencia	Cor	Abertura mm.	Rolos Mt.
	MGO	preto	0,8 - 1,5	100
	107004761 MGO MGO	preto branco cinzento	1,0 - 2,0 1,0 - 2,0 1,0 - 2,0	100 Por encomenda (1000mt min) 100
	MGO MGO MGO	preto branco cinzento	1,0 - 2,0 1,0 - 2,0 1,0 - 2,0	100 100 100
	MGO MGO	preto preto	1,0 - 2,5 2,0 - 4,0	100 100
	MGO	preto	1,0 - 3,0	100
	MGO	preto	1,0 - 4,0	100
	107000599	preto	2,0 - 4,0	100
	MGO	preto	1,0 - 2,5	Por encomenda (1000mt min)

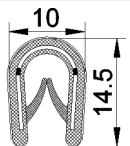
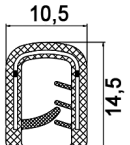
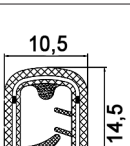
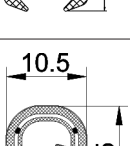
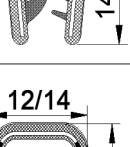
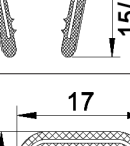
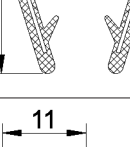
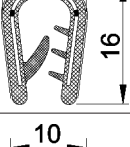
Plano 1:1	Referencia	Cor	Abertura mm.	Rolos Mt.
	MGO MGO MGO MGO	preto antracite cinzento claro branco	1,0 - 4,0 1,0 - 4,0 1,0 - 4,0 1,0 - 4,0	100 100 100 100
	MGO	preto	2,0 - 5,0	100
	MGO	cinzento	2,0 - 5,0	100
	MGO	preto	2,0 - 5,0	100
	MGO MGO MGO MGO	preto cinzento claro preto cinzento claro	6,0 - 8,0 6,0 - 8,0 8,0 - 10,0 8,0 - 10,0	100 100 100 Por encomenda (1000mt min)
	MGO	preto	10,0 - 12,0	100
	MGO MGO	preto preto	2,0 - 4,0 4,0 - 6,0	100 100
	107000598	preto	1,0 - 4,0	100

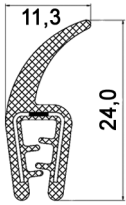
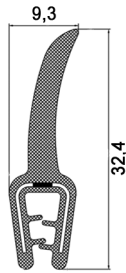
Plano 1:1	Referencia	Cor	Abertura mm.	Rolos Mt.
	MGO 107001497	preto preto	0,5 - 3,0 0,5 - 3,0	100 50
	MGO	preto	1,0 - 2,5	Por encomenda (1000mt min)

Perfis de PVC + borracha com inserção metálica

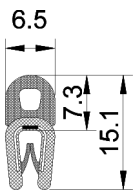
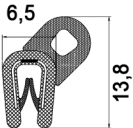
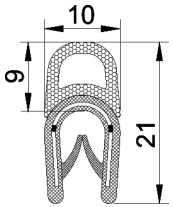
Plano 1:1	Referencia	Cor	Abertura mm.	Rolos Mt.
	MGO	preto	1,0 - 2,0	100
	MGO	preto	1,0 - 2,0	Por encomenda (1000mt min)
	MGO	preto	1,0 - 4,0	50

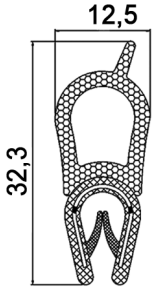
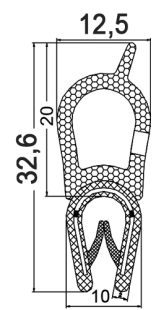
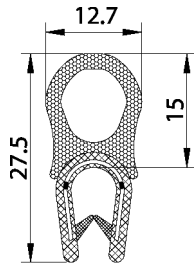
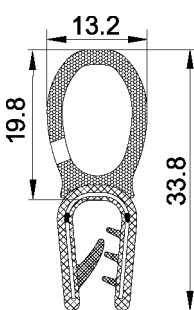
Plano 1:1	Referencia	Cor	Abertura mm.	Rolos Mt.
	MGO	preto	1,0 - 4,0	Por encomenda (1000mt min)
	107000593	preto	1,0 - 4,0	50
	MGO	preto	1,0 - 4,0	50
	MGO MGO MGO	preto preto preto	1,0 - 2,5 2,0 - 4,0 4,0 - 6,0	50 50 50

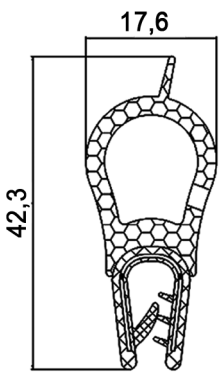
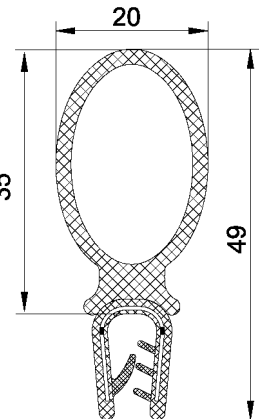
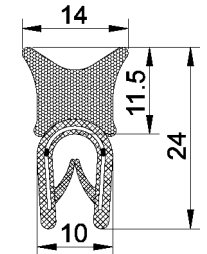
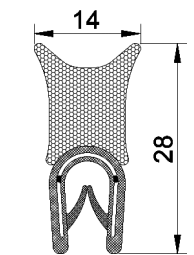
Plano 1:1	Referencia	Cor	Abertura mm.	Rolos Mt.
 <p>Technical drawing of a watch component. The drawing shows a cross-section of a component with a curved, textured top section and a base with a W-shaped structure. Dimensions are indicated: 17,6 for the width of the top section and 42,3 for the total height.</p>	MGO	preto	2,0 - 4,0	Por encomenda (1000mt min)
 <p>Technical drawing of a watch component. The drawing shows a cross-section of a component with a large oval opening and a base with a W-shaped structure. Dimensions are indicated: 20 for the width of the oval, 35 for the height of the oval, and 49 for the total height.</p>	MGO Tubo de EPDM compacto	preto	2,0 - 4,0	25
 <p>Technical drawing of a watch component. The drawing shows a cross-section of a component with a curved top and a base with a W-shaped structure. Dimensions are indicated: 14 for the width of the top section, 11,5 for the height of the top section, and 24 for the total height.</p>	MGO	preto	1,0 - 4,0	50
 <p>Technical drawing of a watch component. The drawing shows a cross-section of a component with a curved top and a base with a W-shaped structure. Dimensions are indicated: 14 for the width of the top section and 28 for the total height.</p>	MGO	preto	1,0 - 4,0	50

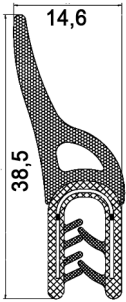
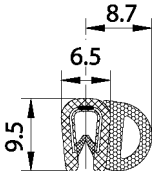
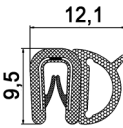
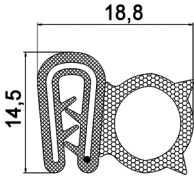
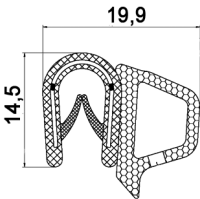
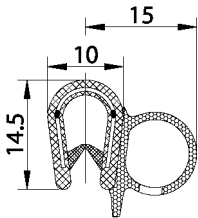
Plano 1:1	Referencia	Cor	Abertura mm.	Rolos Mt.
	MGO	preto	1,5 - 3,5	50
	107000591	preto	1,0 - 2,0	100
	MGO	preto	1,0 - 2,0	Por encomenda (1000mt min)
	MGO	preto	1,0 - 2,5	Por encomenda (1000mt min)
	107000611	preto	1,0 - 4,0	50
	MGO	preto	1,0 - 4,0	50

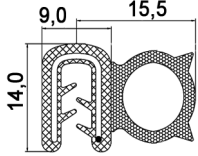
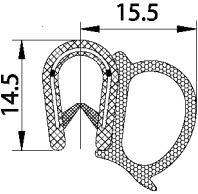
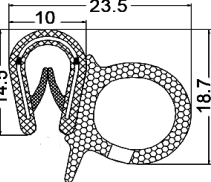
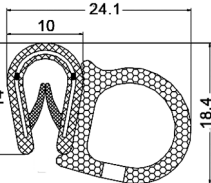
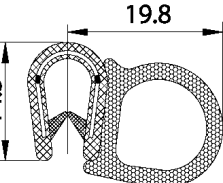
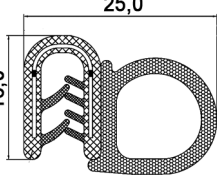
Plano 1:1	Referencia	Cor	Abertura mm.	Rolos Mt.
	MGO	preto	1,0 - 2,5	Por encomenda (1000mt min)
	107000590	preto	1,0 - 4,0	50
	MGO	preto	1,0 - 4,0	50
	MGO	preto	1,0 - 4,0	50
	MGO	preto	1,0 - 4,0	50
	MGO	preto	1,0 - 4,0	50

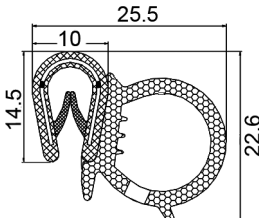
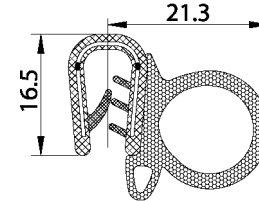
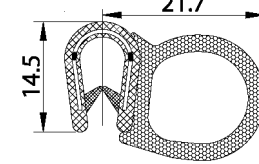
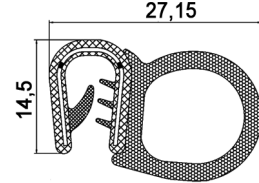
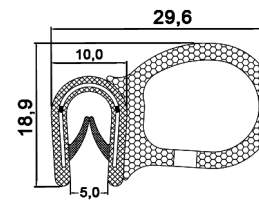
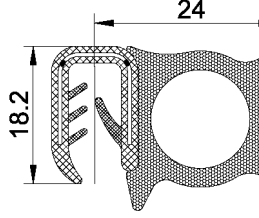
Plano 1:1	Referencia	Cor	Abertura mm.	Rolos Mt.
	MGO	preto	1,0 - 4,0	50
	MGO	preto	2,5 - 4,0	50
	107002679	preto	1,0 - 4,0	50
	MGO	preto	2,0 - 5,0	50
	MGO	preto	1,0 - 4,0	50
	MGO MGO 107008059	preto preto preto	1,0 - 2,5 2,5 - 4,0 4,0 - 6,0	Por encomenda (1000mt min) 50 50

Plano 1:1	Referencia	Cor	Abertura mm.	Rolos Mt.
	MGO MGO MGO	preto preto preto	1,0 - 2,5 2,5 - 4,0 4,0 - 6,0	50 50 Por encomenda (1000mt min)
	MGO Tubo de EPDM compacto	preto	3,0	25
	MGO	preto	1,0 - 4,0	50
	MGO	preto	1,0 - 3,5	50
	107000594	preto	1,0 - 4,0	50

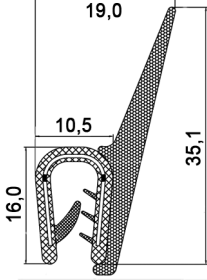
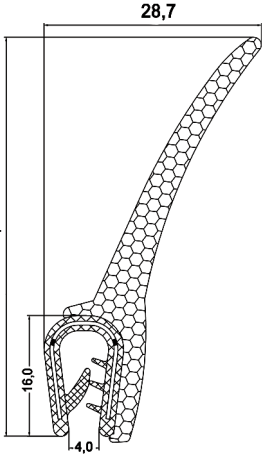
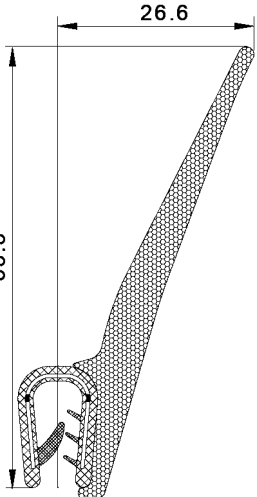
Plano 1:1	Referencia	Cor	Abertura mm.	Rolos Mt.
	MGO	preto	2,5 - 4,0	Por encomenda (1000mt min)
	MGO	preto	2,0 - 4,0	25
	MGO 107008875 MGO	preto preto preto	1,0 - 2,5 2,0 - 4,0 4,0 - 6,0	25 25 25

Perfis de borracha + borracha com inserção metálica

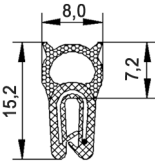
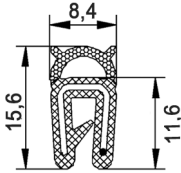
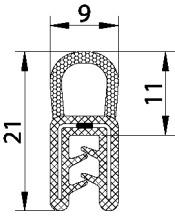
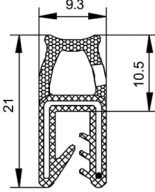
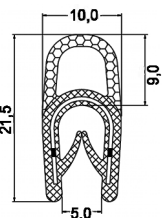
Plano 1:1	Referencia	Cor	Abertura mm.	Rolos Mt.
	MGO	preto	0,5 - 1,5	200
	107006707	preto	1,0 - 2,0	100
	MGO	preto	1,0 - 2,5	100
	MGO	preto	1,0 - 3,0	100
	MGO EPDM IGNIFUGO	preto	1,0 - 4,0	Por encomenda (1000mt min)

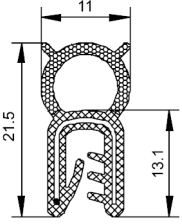
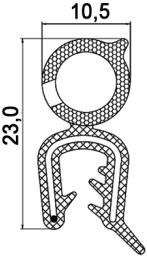
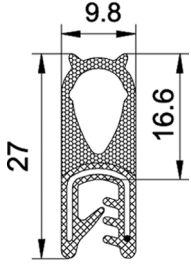
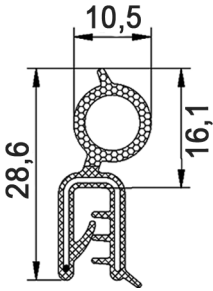
Plano 1:1	Referencia	Cor	Abertura mm.	Rolos Mt.
	MGO EPDM MGO NBR	preto preto	1,0 - 3,0 1,0 - 3,0	100 100
	MGO	preto	2,5 - 3,5	Por encomenda (1000mt min)
	MGO	preto	1,0 - 3,5	100
	MGO	preto	1,0 - 2,5	Por encomenda (1000mt min)

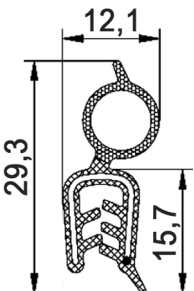
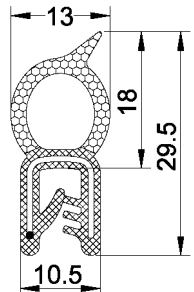
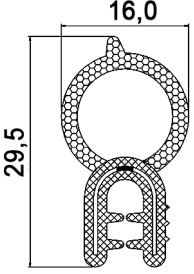
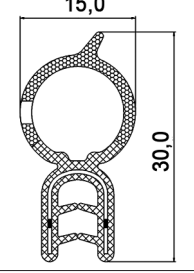
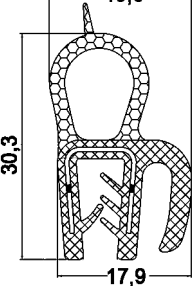
Plano 1:1	Referencia	Cor	Abertura mm.	Rolos Mt.
	MGO	preto	1,5 - 3,5	100
	MGO MGO	preto preto	1,0 - 2,5 2,0 - 4,0	100 100
	MGO	preto	2,5 - 4,0	Por encomenda (1000mt min)
	MGO	preto	2,0 - 3,0	Por encomenda (1000mt min)
	MGO	preto	3,0 - 4,0	Por encomenda (1000mt min)

Plano 1:1	Referencia	Cor	Abertura mm.	Rolos Mt.
	MGO	preto	1,0 - 3,0	50
	MGO	preto	1,0 - 2,0	Por encomenda (1000mt min)
	MGO	preto	1,0 - 3,0	51
	MGO	preto	2,5 - 4,0	Por encomenda (1000mt min)
	MGO EPDM IGNIFUGO	preto	2,0	Por encomenda (1000mt min)

Plano 1:1	Referencia	Cor	Abertura mm.	Rolos Mt.
	MGO	preto	1,5 - 3,5	Por encomenda (1000mt min)
	MGO	preto	2,0 - 3,0	Por encomenda (1000mt min)
	MGO	preto	2,0 - 3,0	Por encomenda (1000mt min)
	107003675	preto	1,0 - 2,5	100
	MGO	preto	0,8 - 2,5	100
	MGO	preto	1,0 - 2,0	100

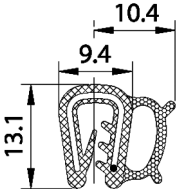
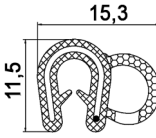
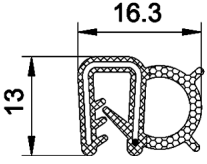
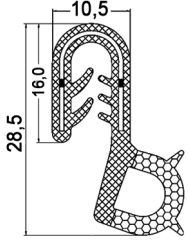
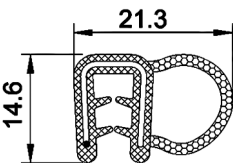
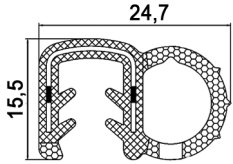
Plano 1:1	Referencia	Cor	Abertura mm.	Rolos Mt.
	MGO	preto	2,0	100
	MGO	preto	1,0 - 2,0	Por encomenda (1000mt min)
	MGO EPDM MGO NBR	preto preto	2,0 2,0	100 100
	MGO	preto	0,8 - 2,0	Por encomenda (1000mt min)
	MGO	preto	1,5 - 3,0	100
	MGO	preto	4,0 - 6,0	Por encomenda (1000mt min)

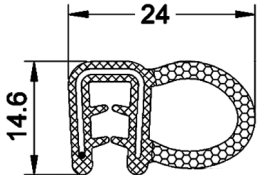
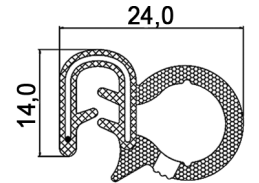
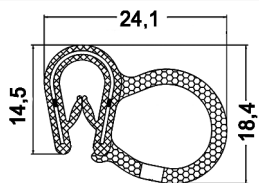
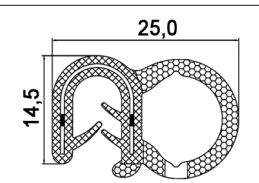
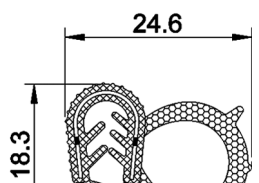
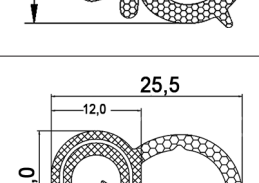
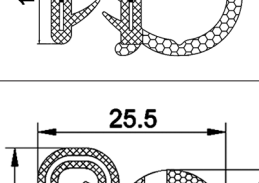
Plano 1:1	Referencia	Cor	Abertura mm.	Rolos Mt.
	MGO	preto	1,5 - 3,0	100
	MGO	preto	2,0 - 4,0	Por encomenda (1000mt min)
	MGO EPDM IGNIFUGO	preto	2,0 - 3,0	Por encomenda (1000mt min)
	MGO	preto	1,5 - 3,0	Por encomenda (1000mt min)
	MGO MGO	preto preto	2,0 - 4,0 4,0 - 6,0	75 75
	MGO	preto	1,5 - 4,0	Por encomenda (1000mt min)
	MGO	preto	2,0	50

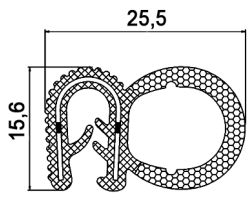
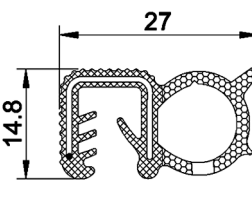
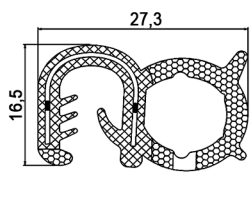
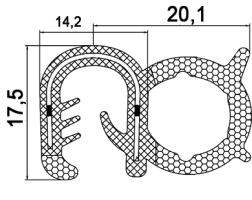
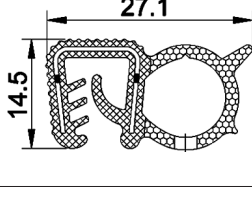
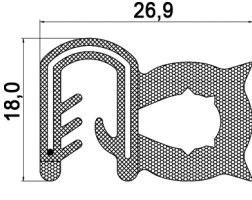
Plano 1:1	Referencia	Cor	Abertura mm.	Rolos Mt.
	MGO	preto	1,0 - 4,0	50
	MGO MGO	preto preto	2,0 - 4,0 5,0 - 6,0	Por encomenda (1000mt min)
	MGO	preto	5,0 - 6,0	Por encomenda (1000mt min)
	MGO	preto	5,0 - 6,0	Por encomenda (1000mt min)
	MGO MGO MGO	preto preto preto	1,0 - 2,5 2,0 - 4,0 5,0 - 6,0	75 75 75
	MGO	preto	3,0 - 5,0	Por encomenda (1000mt min)

Plano 1:1	Referencia	Cor	Abertura mm.	Rolos Mt.
<p>Technical drawing of a roller with dimensions: 10,9, 20,0, 16,3</p>	MGO	preto	3,0 - 4,0	Por encomenda (1000mt min)
<p>Technical drawing of a roller with dimensions: 14,5, 28,0, 15,7</p>	MGO	preto	5,0 - 6,0	Por encomenda (1000mt min)
<p>Technical drawing of a roller with dimensions: 15,0, 28,5, 17,5</p>	107008560	preto	5,0 - 9,0	50
<p>Technical drawing of a roller with dimensions: 10,7, 26,4, 18,5</p>	MGO	preto	2,0 - 4,0	Por encomenda (1000mt min)
<p>Technical drawing of a roller with dimensions: 14,0, 28,3, 17,4</p>	MGO	preto	5,0 - 6,0	Por encomenda (1000mt min)

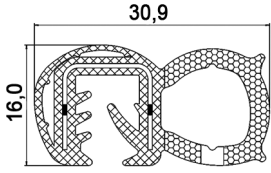
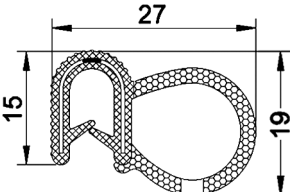
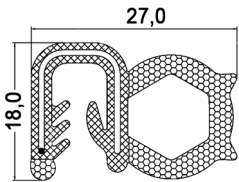
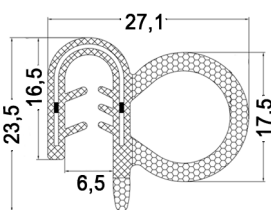
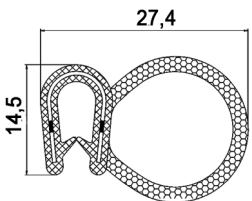
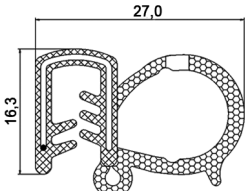
Plano 1:1	Referencia	Cor	Abertura mm.	Rolos Mt.
	MGO	preto	6,0	Por encomenda (1000mt min)
	MGO MGO CR	preto preto	1,0 - 3,5 1,0 - 3,5	50 75
	MGO	preto	2,5 - 4,5	Por encomenda (1000mt min)
	MGO	preto	4,0 - 5,0	Por encomenda (1000mt min)
	107008876	preto	1,5 - 3,0	50
	MGO	preto	2,0 - 4,0	Por encomenda (1000mt min)

Plano 1:1	Referencia	Cor	Abertura mm.	Rolos Mt.
	MGO	preto	3,0	Por encomenda (1000mt min)
	MGO	preto	4,0 - 6,0	Por encomenda (1000mt min)
	MGO	preto	5,0 - 6,0	Por encomenda (1000mt min)
	MGO	preto	5,0 - 6,0	Por encomenda (1000mt min)
	MGO	preto	5,0 - 6,0	Por encomenda (1000mt min)
	MGO	preto	4,0 - 6,0	Por encomenda (1000mt min)

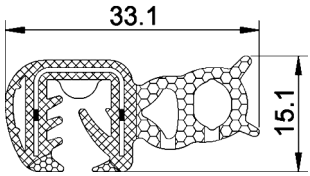
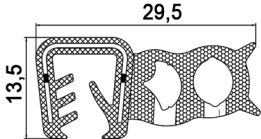
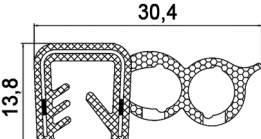
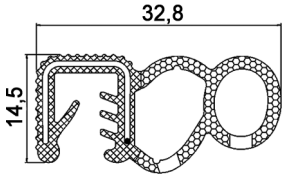
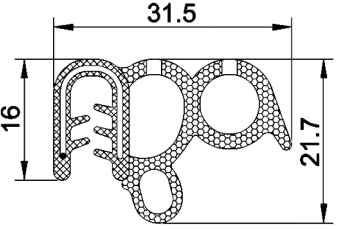
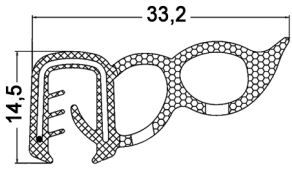
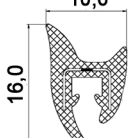
Plano 1:1	Referencia	Cor	Abertura mm.	Rolos Mt.
	MGO	preto	5,0 - 6,0	Por encomenda (1000mt min)
	MGO	preto	5,0 - 6,0	Por encomenda (1000mt min)
	MGO	preto	5,0 - 6,0	Por encomenda (1000mt min)
	MGO	preto	5,0 - 6,0	Por encomenda (1000mt min)
	107005003	preto	1,5 - 3,5	50
	MGO	preto	3,0	Por encomenda (1000mt min)
	MGO EPDM IGNIFUGO	preto	-	Por encomenda (1000mt min)

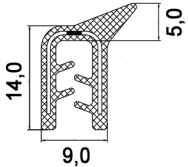
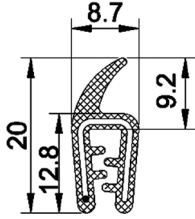
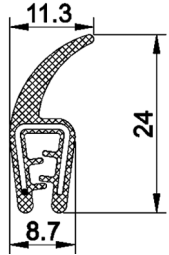
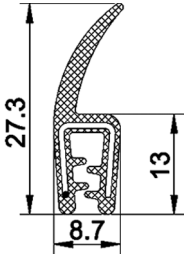
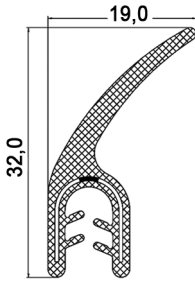
Plano 1:1	Referencia	Cor	Abertura mm.	Rolos Mt.
	MGO	preto	1,5 - 3,0	Por encomenda (1000mt min)
	MGO	preto	1,0 - 2,0	100
	MGO	preto	1,0 - 2,5	150
	MGO	preto	1,0 - 3,0	100
	MGO	preto	2,0 - 4,0	Por encomenda (1000mt min)

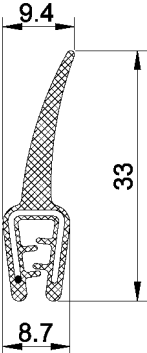
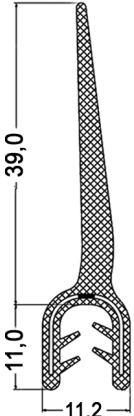
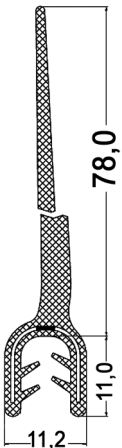
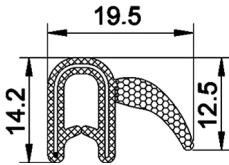
Plano 1:1	Referencia	Cor	Abertura mm.	Rolos Mt.
	MGO	preto	1,0 - 2,5	100
	MGO	preto	2,0 - 4,0	Por encomenda (1000mt min)
	MGO	preto	2,0 - 4,0	Por encomenda (1000mt min)
	MGO	preto	1,0 - 3,0	150

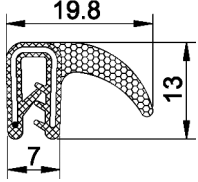
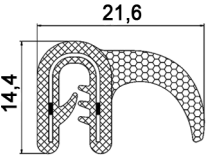
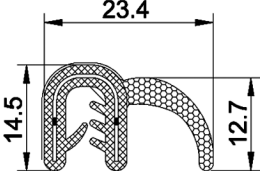
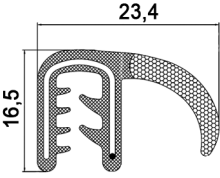
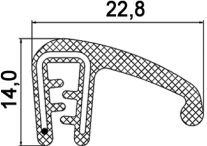
Plano 1:1	Referencia	Cor	Abertura mm.	Rolos Mt.
	MGO	preto	1,0 - 2,0	100
	MGO	preto	1,0 - 2,5	100
	MGO	preto	1,25 - 2,0	100
	MGO	preto	2,0 - 3,0	Por encomenda (1000mt min)
	MGO	preto	1,0 - 2,5	Por encomenda (1000mt min)

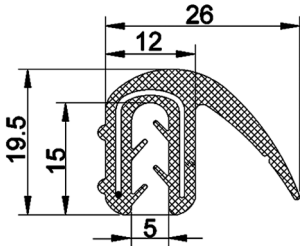
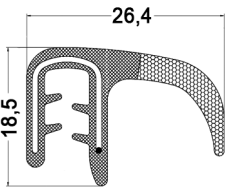
Plano 1:1	Referencia	Cor	Abertura mm.	Rolos Mt.
	MGO	preto	1,0 - 3,5	75
	MGO	preto	4,0	Por encomenda (1000mt min)

Perfis de borracha com inserção metálica

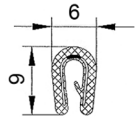
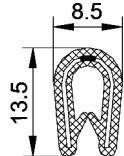
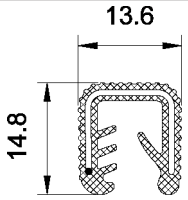
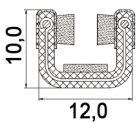
Plano 1:1	Referencia	Cor	Abertura mm.	Rolos Mt.
	MGO	preto	1,0 - 2,0	Por encomenda (1000mt min)
	MGO	preto	1,0 - 3,0	Por encomenda (1000mt min)
	MGO	preto	5,0 - 6,0	Por encomenda (1000mt min)
	MGO	preto	-	Por encomenda (1000mt min)

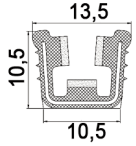
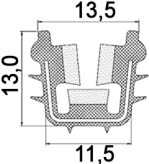
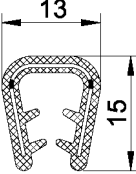
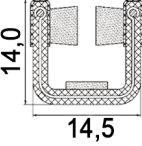
Plano 1:1	Referencia	Cor	Abertura mm.	Rolos Mt.
	MGO	preto	-	Por encomenda (6000mt min)
	MGO	preto	-	Por encomenda (6000mt min)
	MGO	preto	-	Por encomenda (1000mt min)
	MGO	preto	-	Por encomenda (1000mt min)